



ELYSIUM

LX60B Pro



OPERATING INSTRUCTIONS

Please keep for future reference

Thank you for purchasing this Elysium LX60B Pro charger. We are sure you will be pleased with its performance and features. In order to ensure that you obtain the maximum benefit from its operation, please read these instructions carefully.

SPECIFICATIONS

Input Voltage	11~15V DC, 100V~240V AC / 50~60Hz
Battery Type & Cells	1~6 Lithium-Ion or Lithium-Polymer cells (3.6V or 3.7V respectively) 1~6 LiFePO4 cells (3.3V) 1~14 Nickel-Cadmium cells 1~14 Nickel-Metal Hydride cells 1 - 6 Lead-Acid cells (2V per cell)
Battery Capacity	100mAh ~ 6000mAh adjustable ONLY for Lithium-Ion, Lithium-Polymer and LiFePO4
Charge Rate	0.1A ~ 6A Adjustable in 100mA steps (2C charge rate available for Li-Po Batteries)
Discharge Rate	0.1A ~ 1A in 10mA steps (auto limited to 5W max)
Trickle Charge Rate	0 ~ 200mA
Balancing	Max. Current 280mA (Tolerance 5mV during charge or discharge)
Charge Termination	"Zero Delta V" peak detection for NiCd/NiMH "Constant current / constant voltage" for Li-Ion/Po LiFe and Pb
Delta Peak Sensitivity	5mV ~ 25mV for NiCd & 3mV ~ 25mV for NiMH (per cell)

SPECIAL FEATURES

- Pack Cycling (Charge to Discharge / Discharge to Charge)
- 2 -line, 16 character, blue backlit, LCD makes the screen extremely clear and legible.
- Built-in intelligent balancing circuit is designed to individually balance each cell on the connected lithium battery pack within the tolerance of 5mV during charge or discharge.
- Balancing plug adaptor boards are supplied to suit Polyquest, FlightPower and Thunder Power batteries. Optional adaptors for JST XH are available.
- Voltage monitoring feature shows each actual cell voltage on the screen during balancing.
- Various warning messages for incorrect input voltage, wrong connections, unsuitable battery condition and reverse polarity on output.
- Packaged in a rugged aluminium case.

SAFETY PRECAUTIONS

- **DO NOT** attempt to charge incompatible types of rechargeable batteries. This charger is designed to only charge and discharge Nickel-Cadmium, Nickel-Metal Hydride, Lithium-Ion, Lithium-Polymer, LiFePO₄ and Lead-Acid batteries.
- Make sure you place the charger on a firm level surface for charging.
- **DO NOT** attempt to charge batteries at excessive fast charge currents. Check with your battery manufacturer for the maximum charge rate applicable to your battery.
- **DO NOT** use automotive type battery chargers to power the charger.
- **DO NOT** leave the charger unattended while charging. Disconnect the battery and remove input power from charger immediately if the charger becomes hot. Allow the charger or battery to cool down before reconnecting.
- **DO NOT** allow water, moisture or foreign objects into the charger.
- **DO NOT** place the battery or charger on or near a flammable object while in use. Keep away from carpets, cluttered workbenches, etc.
- **DO NOT** cover the air intake holes on the charger as this could cause the charger to overheat.
- Connect the input leads to the mains, or a 12V power supply first, then connect the battery.
- **DO NOT** disassemble the charger.
- This unit is **not intended** for use by young children or infirm persons unless they have been adequately supervised by a responsible person to ensure that they can use it safely.
- Young children should be **supervised** to ensure that they do not play with the Elysium LX60B Pro.
- **DO NOT** attempt to charge non-rechargeable batteries.
- The battery must be placed in a well ventilated area (for charging lead-acid batteries)
- **After charging**, disconnect the battery charger from the power supply first, then disconnect the battery.

LITHIUM ION/POLYMER BATTERY SAFETY WARNINGS

Ensure that the charger and battery are placed on a non-flammable surface whilst charging and ideally charge outdoors wherever possible.

NEVER charge a Lithium ION/Polymer/Fe battery inside a vehicle whatever the circumstances.

ALWAYS ensure that the charger is correctly set for the battery being charged, checking both voltage and capacity. Be particularly careful if using a series/parallel battery pack, or if using packs of different specifications with the same charger.

NEVER charge at a rate higher than that recommended by the cell manufacturer, this can be very dangerous.

DO NOT leave Lithium ION/Polymer/Fe batteries unattended whilst they are charging. Monitoring the batteries during charging is very important.

ALWAYS monitor the temperature of the battery being charged every few minutes. If the battery becomes hot to the touch, disconnect it from the charger immediately and allow to cool. **DO NOT** recommence charging until the battery and charger have been checked for compatibility and the charger settings have been confirmed as being correct.

In the unlikely event of the Lithium ION/Polymer/Fe battery catching fire **DO NOT** use water to attempt to put the fire out, instead use sand or a fire extinguisher designed for electrical fires.

When used correctly, Lithium ION/Polymer/Fe battery packs are as safe as any other type of rechargeable battery pack. However they do require different charge regimes to the longer established Nickel Cadmium and Nickel Metal Hydride technologies and **have the potential of catching fire if severely mistreated.**

If Lithium Polymer battery packs are short-circuited or severely over-charged elemental Lithium may be deposited internally, and if the battery pouch is damaged this can escape from inside the battery. If this occurs a fire may be caused, as elemental **Lithium is highly reactive when exposed to water or moisture**, producing flammable hydrogen gas and corrosive fumes. Elemental Lithium is not produced unless the battery pack is severely mistreated, so in normal usage there is no likelihood of explosion or fire.

LITHIUM ION/POLYMER/LiFe BATTERIES

Lithium battery packs must **NEVER** be discharged below 3 volts per cell as this will result in damage to the cells. If the voltage is allowed to drop below 3 volts per cell the battery voltage may seem to recover following a charge, but the battery may not then give its full nominal capacity and a reduction in performance is likely – allowing the voltage to drop below 3 volts per cell will invalidate all warranty claims.

NEVER charge Lithium Polymer battery packs at greater than 4.2V per cell, Lithium Ion at 4.1V volts per cell or LiFe at greater than 3.7V per cell as this will cause irreversible damage to the cells and will invalidate all warranty claims.

DO NOT use discharge rates in excess of those specified with the battery pack as this will result in a significant drop in voltage under load and will dramatically reduce the number of charge/discharge cycles the battery pack will give.

DO NOT attempt to charge Lithium battery packs whilst the input 12 volt battery is being charged, as the voltage supplied to the Lithium Polymer charger may be too high.

If disposing of Lithium battery packs ensure that the pack is fully discharged by using a light bulb, electric motor or similar to completely discharge the pack.

DO NOT allow any Lithium battery pack to short-circuit as this is likely to result in a minor explosion and consequent fire.

BEFORE charging any Lithium battery packs they should be closely inspected for any damage, such as punctures in the sleeving or if the battery has swollen or expanded in size. If any such damage is detected **DO NOT** charge, even if the battery otherwise appears to be brand new.

Before commencing charging **ALWAYS** double check the settings on the charger to ensure it is set correctly for the battery pack to be charged. Using the wrong settings is likely to result in damage to the battery pack being charged and could result in the battery catching fire.

INPUT POWER

12V DC

Connect the charger's red alligator clip to the positive (+) terminal on the power source and the black alligator clip to the negative (-) terminal. The charger will display "Input voltage" error message if the input is below 11V or above 15V. If this happens, please recheck the input power supply to make sure correct power is present.

OR

100~240V AC

Connect the mains lead to the Fusion Elysium LX60B Pro, then connect the AC plug to a regular AC100~240V wall socket.

NOTE:

If AC power is being used for input power, do NOT try to connect the 12V DC power as well!

OUTPUT BATTERY CONNECTIONS

Two 4mm banana sockets are located on the right side of the charger. Connect the battery main power leads to these sockets with the positive (+) lead connected to the red socket and the negative (-) lead to the black socket. You may need to purchase an adaptor lead to suit the specific connector on your battery and make this more convenient. The "No battery" error message will be displayed if trying to start charging without connecting a battery to these sockets. The "Open Circuit" error message will be displayed if a battery becomes disconnected from the charger while a function is in progress. A "Reverse Polarity" error message will be displayed if a battery is connected to the charger in reverse.

Note: In order to balance Lithium batteries during charge or discharge, please ensure that both the battery main power leads and the balancing connector from the battery pack are connected to both 4mm output banana sockets and balancing port respectively. The balancing port requires a short lead (supplied) and an adaptor board to suit your battery balance connector. Two types are supplied to suit Impulse (PQ), Flight Power and Thunder Power batteries (TP). Other types are available as options (JST EH, JST XH).

If the main battery power leads ONLY are connected to the output banana sockets, without connecting the balancing connector to the balancing port on the charger, the charger will charge or discharge the connected Lithium pack without balancing it.

- If the other buttons are pressed, or nothing is pressed, the present battery type stops flashing.
- If the Battery TYPE button is pressed and briefly held, the recent & previous data will be shown until the Battery TYPE button is pressed.
- If the ENTER button is briefly pressed, a parameter which can be adjusted starts to flash and if the ENTER button is pressed again, the next parameter starts to flash. If nothing is pressed for 3 seconds, the parameter stops flashing.
- Once the ENTER button is pressed and briefly held, the charger starts to charge or discharge according to the selected parameters.

NiCd CHARGE
C=3.0A

Setting Charge Current

Adjust the desired charge current, which ranges from 0.1A to 6.0A with the INC & DEC buttons. Press the ENTER button to confirm the setting.

NiCd DISCHARGE
D=0.5A 4.8V

Setting Discharge Current

Adjust the desired discharge current, which ranges from 0.1A to 1A with the INC & DEC buttons. Press the ENTER button to confirm the setting. The current will be automatically limited to maintain 5W maximum.

NiCd DISCHARGE
D=0.5A 4.8V

Setting Discharge Cutoff Voltage

This is the voltage that the charger will stop discharging the battery at. Adjust the total discharge cutoff voltage from 0.1V to 16.8V with the INC & DEC buttons. Press the ENTER button to confirm the setting.

NiCd CYCLE C->D 5
C=3.0A D=0.5A

Setting Cycle

This is to set cycling with two options (Charge to Discharge / Discharge to Charge). Set cycling with the INC & DEC buttons and press the ENTER button to confirm the setting.

NiCd delta-peak-
volt = 0mV/cell

Setting Delta Peak Sensitivity

Set the Delta Peak Sensitivity from 5mV to 25mV per cell with the INC & DEC buttons and press the ENTER button to confirm the setting.

Lithium Modes (Li-Ion/Li-Po/Li-Fe)

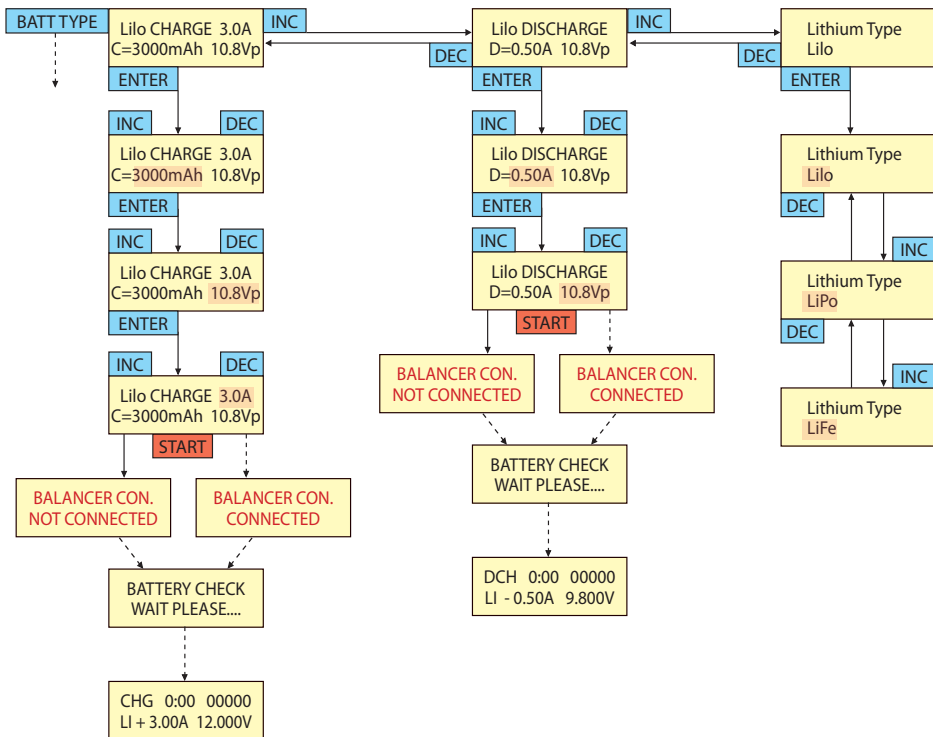

This charger is capable of charging up to 6 cell Lithium-Ion, Lithium-Polymer or LiFePO4 batteries. It uses “constant current / constant voltage” regime in order to fully charge these Lithium batteries. Constant current is delivered during the fast charge. When the voltage of the Li-Ion, Li-Po battery and LiFePO4 reaches approx 4.1V, 4.2V, and 3.7V per cell respectively, the charger starts to change its charge method from “constant current” to “constant voltage”. The “constant voltage” allows the battery to dictate how much current the charger should deliver for safe, full charges. When the current drops below approx 1/10th current of the user selected battery capacity, the charger will stop charging as the battery is fully charged.

Lilo CHARGE 3.0A
C=3000mAh 10.8Vp

Setting Battery Capacity

Adjust the desired battery capacity from 100mAh to 6000mAh (50mAh per step) with the INC & DEC buttons. Press the ENTER button to confirm the setting.

Lilo CHARGE 3.0A
C=3000mAh 10.8Vp

Setting Battery Voltages For Li-Ion Battery Pack

Select the correct total battery voltage to be charged or discharged with the INC & DEC buttons – 3.6V, 7.2V, 10.8V, 14.4V, 18.0V and 21.6V [Vpack].

LiPo CHARGE 3.0A
C=3000mAh 11.1Vp

Setting Battery Voltages For Li-Po Battery Pack

Select the correct total battery voltage to be charged or discharged with the INC & DEC buttons – 3.7V, 7.4V, 11.1V, 14.8V, 18.5V and 22.2V [Vpack].

LiFe CHARGE 3.0A
C=3000mAh 11.1Vp

Setting Battery Voltages For Li-Fe Battery Pack

Select the correct total battery voltage to be charged or discharged with the INC & DEC buttons – 3.3V, 6.6V, 9.9V, 13.2V, 16.5V and 19.8V [Vpack].

Lilo CHARGE 3.0A
C=3000mAh 10.8Vp

Setting Charge Current

Always set the capacity first. When the capacity has been set, the current will automatically show an equivalent of 1C. For instance, a 3000mAh battery will initially show 3A. This can be varied up to 2C (6A max) or down to 0.1A using the INC & DEC buttons. That current may be further limited automatically to a lower value if the charging power exceeds 50W (Amps x Volts).

IMPORTANT NOTE

For safety purposes, this charger is designed to automatically deliver a 1C charge rate to batteries of Li-Ion, Li-Po or Li-Fe, based on the user selected battery capacity unless over-ridden **only for batteries designed to accept 2C charging**.

Example: Li-Po cell of 1500mAh capacity : 1C = 1500mAh (= 1.5A) charge current.

Lilo DISCHARGE
D=0.50A 10.8Vp

Setting Discharge Current

Adjust the desired discharge current from 0.10A to 1.00A (0.01A per step) with the INC & DEC buttons. Press the ENTER button to confirm the setting. This current will be automatically limited to maintain 5W maximum.

Lithium Type
LiPo

Setting Battery Type

Choose the desired battery type (Li-Ion, Li-Po or Li-Fe) with the INC & DEC buttons. Press the ENTER button to confirm the setting.

IMPORTANT NOTE

The maximum voltage for Li-Ion is 4.1V per cell, 4.2V per cell for Li-Po batteries and 3.7V per cell for Li-Fe batteries. Therefore, it is extremely important to choose the correct Lithium battery type to be charged, as each Lithium battery has a different voltage level. If not, it may cause very serious damage to the batteries and **increase the risk of a fire!**

BALANCER CON.
NOT CONNECTED

The left screen will be shown if the Lithium charge or discharge starts without the balancing cable connected to the balancing port of the charger.

BALANCER CON.
CONNECTED

The left screen will be shown if the Lithium charge or discharge starts with the balancing cable connected to the balancing port of the charger.

Pb Mode

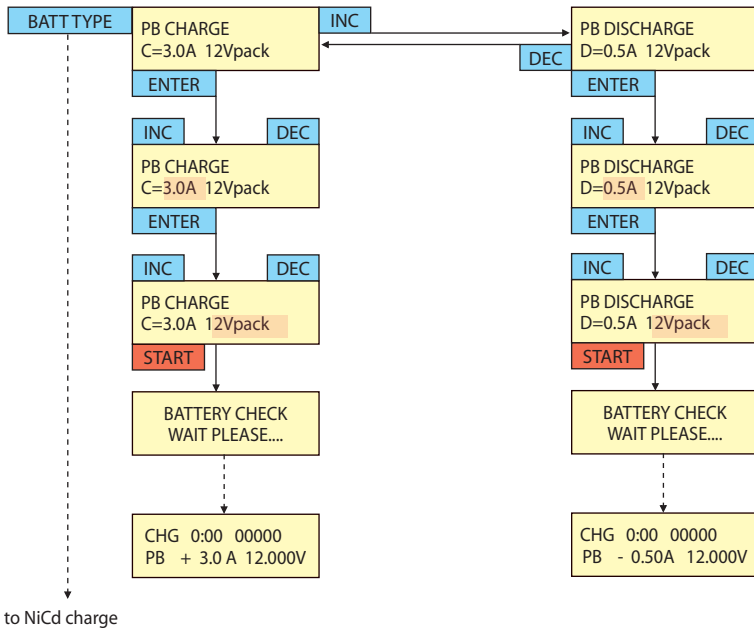

PB CHARGE
C=3.0A 12Vpack

Setting Charge Current

Adjust the desired charge current, which ranges from 0.1A to 6.0A with the INC & DEC buttons. Press the ENTER button to confirm the setting.

PB CHARGE
C=3.0A 12Vpack

Setting Battery Voltages For a Lead-Acid (Pb) Battery Pack

Select the correct total battery voltage to be charged or discharged with the INC & DEC buttons – 2V, 4V, 6V, 8V, 10V, and 12V [Vpack].

PB DISCHARGE
D=0.50A 12Vpack

Setting Discharge Current

Adjust the desired discharge current from 0.10A to 1.00A (0.01A per step) with the INC & DEC buttons. Press the ENTER button to confirm the setting.

SCREEN DISPLAYS

Displays During Charge, Discharge and Cycle

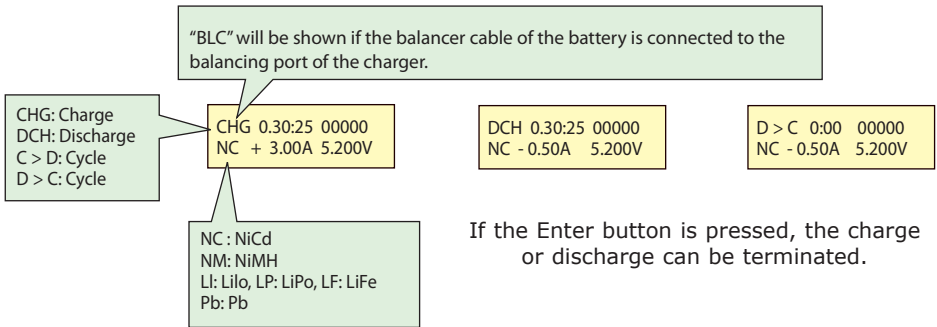

Completion Display (with Audible Warning)

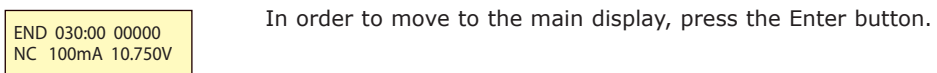

Data Display

In order to move to the main display, press the Enter button.

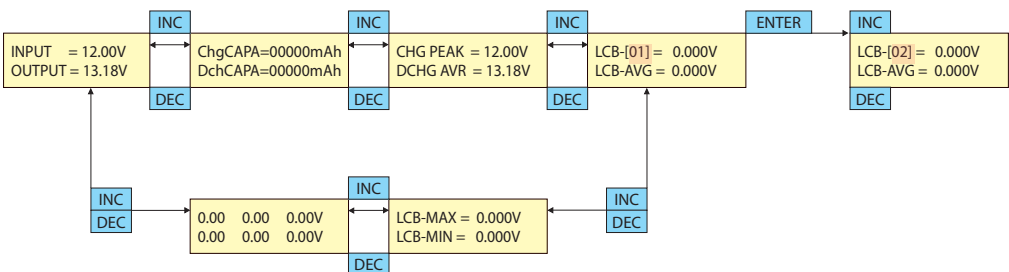

If the Battery TYPE button is pressed for over 3 seconds, the Data view will be displayed as above. Data displays can be scrolled left and right by using the INC & DEC buttons. If the Battery TYPE button is pressed again, the data view screen will disappear.

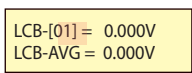

This screen only shows a value if a balancing adaptor is connected. Press the ENTER button, the "01" should flash, each cell voltage is shown by INC & DEC buttons.

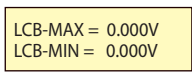

This screen only shows a value if a balancing connector is connected. It shows the maximum and minimum voltage on the screen.

ERROR MESSAGES

INPUT BATTERY
VOLTAGE ERROR

Input voltage is below 11.0V or exceeds 15V.

NO BATTERY

Battery is not connected to the charger's output banana sockets.

OUTPUT BATTERY
REVERSE POLARITY

Battery is connected to the output banana sockets in reverse.

OUTPUT CIRCUIT
PROBLEM

The circuit of the charger has a problem.

CHECK THE BATT.
OPEN CIRCUIT

Battery has become disconnected during an operation.

CHECK THE BATT.
OVER VOLTAGE

Wrong voltage is set while charging Lithium or Pb batteries.

CHECK THE BATT.
LOW VOLTAGE

Wrong voltage is set, or batteries are over discharged, while charging Lithium or Pb batteries.

BALANCER VOLTAGE
IS TOO HIGH

Voltage per cell is too high during balancing. The pack may be faulty.

BALANCER VOLTAGE
IS TOO LOW

Battery cells are short-circuited during balancing. The pack may be faulty.

DON'T CHARGE LiXX
WITH THIS MODE

If the charger attempts to start charging, discharging, or cycling with settings for NiCd/MH, or Pb batteries while there is a balancing cable connected to the balancing port of the charger. This helps prevent charging Lithium batteries in the wrong charge mode.

www.LOGICRC.COM

**Logic RC Limited
14 Hartham Lane
Herford
SG14 1QN
United Kingdom**